

ROLAND GK-2A DIVIDED PICKUP

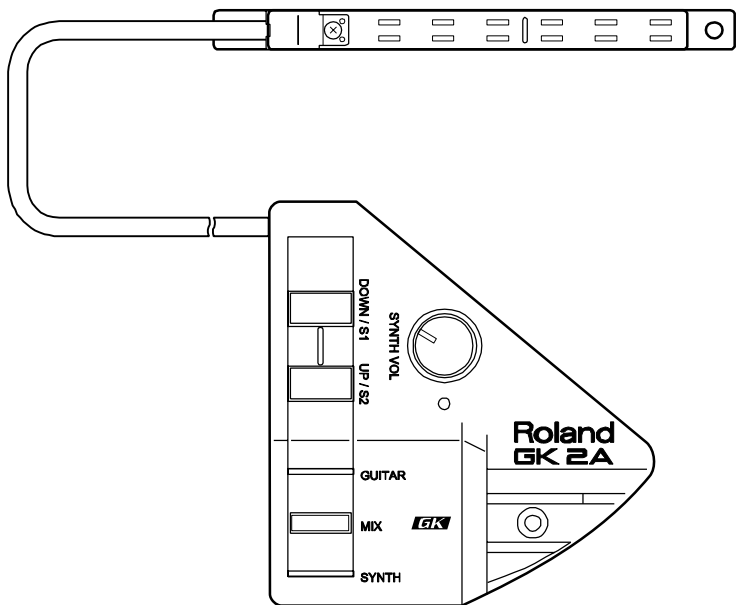

EXPLODED VIEW

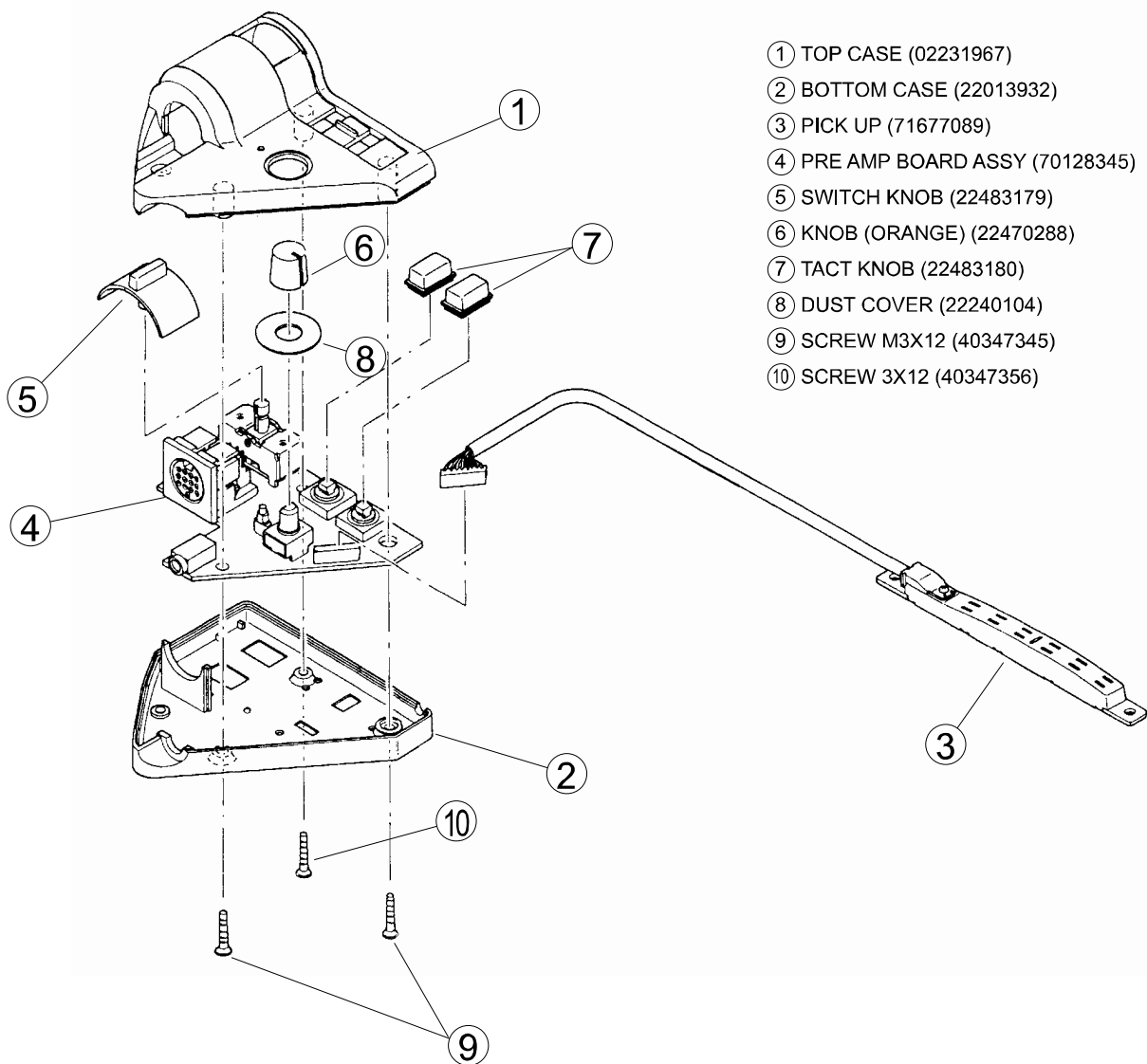

- ① TOP CASE (02231967)
- ② BOTTOM CASE (22013932)
- ③ PICK UP (71677089)
- ④ PRE AMP BOARD ASSY (70128345)
- ⑤ SWITCH KNOB (22483179)
- ⑥ KNOB (ORANGE) (22470288)
- ⑦ TACT KNOB (22483180)
- ⑧ DUST COVER (22240104)
- ⑨ SCREW M3X12 (40347345)
- ⑩ SCREW 3X12 (40347356)

ROLAND GK-2A DIVIDED PICKUP - CIRCUIT DIAGRAM

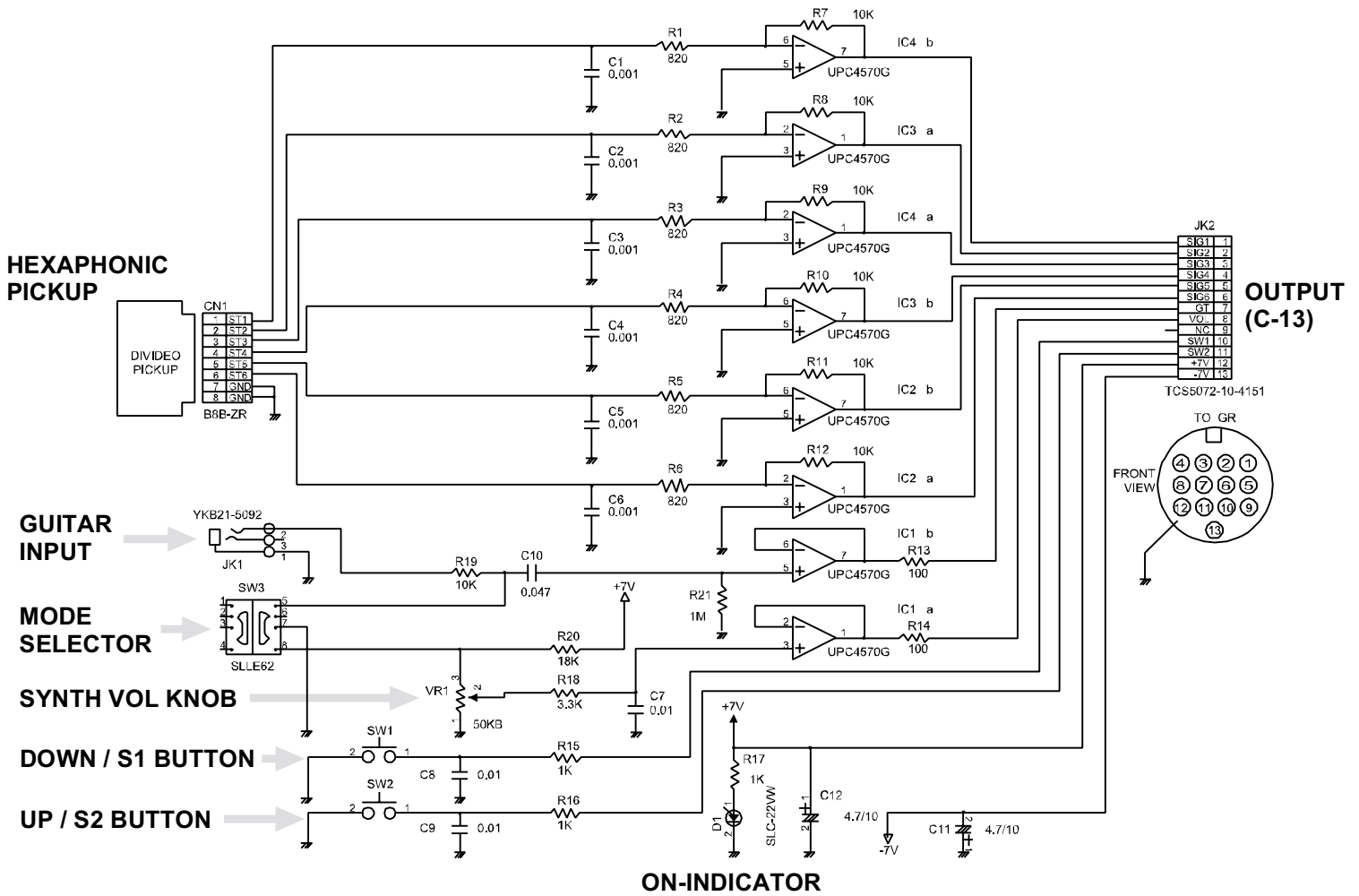

ROLAND GK-2A DIVIDED PICKUP - PCB

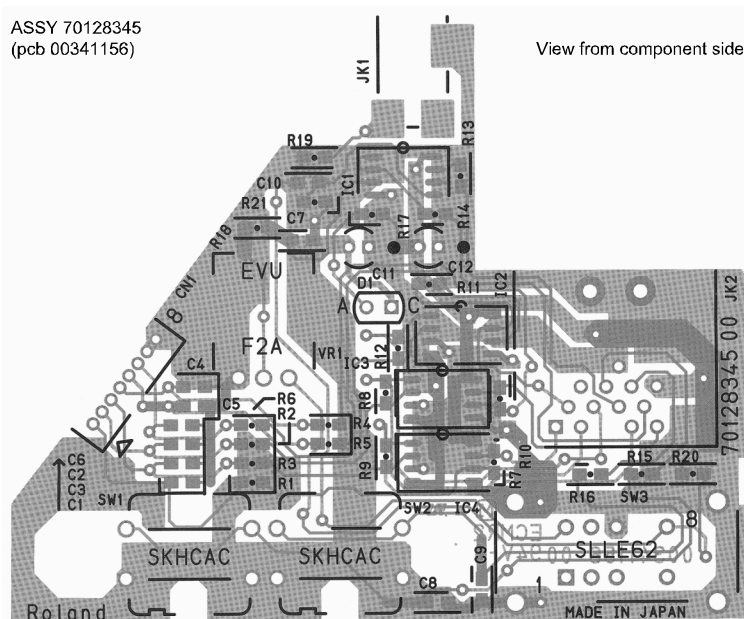

PARTS LIST

SAFETY PRECAUTION:*1

The parts marked  have safety-related characteristics. Use only listed parts for replacement.

The parts marked # are new (initial parts). *2

CONSIDERATIONS ON PARTS ORDERING

When ordering any parts listed in the parts list, please specify the following items in the order sheet.

QTY	PART NUMBER	DESCRIPTION	MODEL NUMBER
Ex 10	22575241	Sharp key	C-20/50
15	2247017300	Knob (orange)	DAC-15D

Failure to completely fill the above items with correct number and description will result in delayed or even undelivered replacement.

Pre--> PRE AMP BOARD ASSY

CASING

22013932	BOTTOM CASE	201-932	1
# 02231967	TOP CASE		1
22240104	DUST COVER		1

KNOB, BUTTON

22470288	KNOB (ORANGE)	247-288	SYNTH VOL SELECT SW (GUITAR/MIX/ SYNTH)	1
22483179	SWITCH KNOB	248-179		1
22483180	TACT KNOB	248-180	DOWN/S1,UP/S2	2

SWITCH

00342501	SLLE62345A	TOGGLE SWITCH	SW3 on Pre	1
13129742	SKHCHC	TACT SWITCH	SW1,SW2 on Pre	2

JACK, EXP TERMINAL

00673790	TCS5072-10-4122 GK IN	DIN CONNECTOR	JK1 on Pre	1
13449277	YKB21-5092	MINI JACK	JK2 on Pre	1

PICKUP ASSY

# 71677089	PICK UP			1
NOTE: Replacement PICK UP should be made on a unit base.				

PCB ASSY

70128345	PRE AMP BOARD ASSY			1
NOTE: 'PRE AMP BOARD ASSY' includes the following parts.				
00237623	LED SPACER	TQ81120020	on Pre	1

IC

15289105	UPC4570G2-E2	IC (BIPOLAR OP AMP)	on Pre	4
----------	--------------	---------------------	--------	---

DIODE

15029296	SLC-22VW3F	LED (RED)	on Pre	1
----------	------------	-----------	--------	---

RESISTOR

15399373	RPC10T 101 J 1/10W	MTL.FILM RESISTOR	on Pre	2
15399395	RPC10T 821 J	MTL.FILM RESISTOR	on Pre	6
15399397	RPC10T 102 J 1/10W	MTL.FILM RESISTOR	on Pre	3
15399409	RPC10T 332 J 1/10W	MTL.FILM RESISTOR	on Pre	1
15399421	RPC10T 103 J 1/10W	MTL.FILM RESISTOR	on Pre	7
15399427	RPC10T 183 J	MTL.FILM RESISTOR	on Pre	1
15399469	RPC10T 105 J 1/10W	MTL.FILM RESISTOR	on Pre	1

POTENTIOMETER

13279927	EVUF2A15B54 9FAI	POTENTIOMETER	on Pre	1
----------	------------------	---------------	--------	---

CAPACITOR

00233789	ECUV1H10 0.001UF/50V	CERAMIC CAPACITOR	on Pre	6
15359223	ECJ2VB1E473K	CERAMIC CAPACITOR	on Pre	1
15359448	ECJ2VB1H103K 0.01F/50V	CERAMIC CAPACITOR	on Pre	3
00341189	10SC4R7M+TS 4.7UF/10V	CERAMIC CAPACITOR	on Pre	2

CONNECTOR

00341212	B8B-ZR	CONNECTOR	on Pre	1
----------	--------	-----------	--------	---

SCREW

# 40347345	SCREW M3X12	FLAT MACHING BZC		2
# 40347356	SCREW 3X12	FLAT TAPTITE P BZC		1

PACKING

# 02231945	PACKING CASE			1+1
------------	--------------	--	--	-----

ACCESSORIES (STANDARD)

# 71780623	HOLDER ASSY			1
# 02238823	OWNER'S MANUAL	ENGLISH/JAPANESE		1
# 71677067	ACCESSORIES KIT			1

NOTE: 'ACCESSORIES KIT' includes the following parts.

22563436	CLEARANCE GAUGE			1
22163573	DOUBLE SIDED ADHESIVE TAPE	TAPE A (.3/25/15) FOR FIX		3
00347945	DOUBLE-FACED TAPE			4
00342545	PICKUP CUSHION	2X8X13		2
22263250	TB-25A LP SPACER	226-250 (2/25/15)		6
00345412	VELCRO FASTENER			1
00342512	PICKUP SPACER A	2X8X13		5
00342534	PICKUP SPACER B	0.5X8X13		10
22173181	COILED SPRING	217-181		2
# 40347378	SCREW 3X20	PAN TAPPING A BZC		2
# 40347389	SCREW 3X16 BZC	FLAT TAPPING A BZC		1
# 40347523	WING NUT M4	BZC		1
40347612	WASHER M4	PLAIN BZC		1
40347534	WASHER M4	SPRING BZC		1
23483226	GUITAR CABLE	348-226		1

PARTS FOR INSTALLATION

Tapping Flat A1 3 x 16 mm

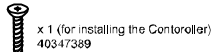

Tapping Pan A1 3 x 20 mm

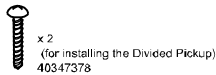

Spring



LP spacer



Double-sided tape A

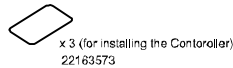

Double-sided tape B

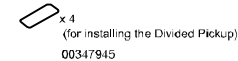

Pickup cushion



Pickup Spacer A

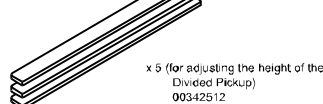

Pickup Spacer B

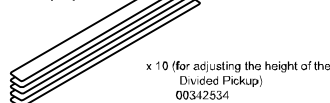

Velcro fastener

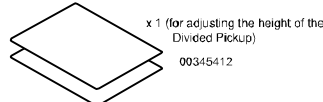

Holder Set

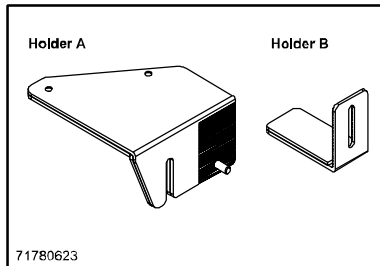

Wing Nut

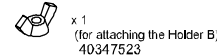

Spring Washer

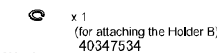

Washer

